

Evaluation Board for the **ADE7953** Single Phase Energy Metering IC

GENERAL DESCRIPTION

The **ADE7953** evaluation kit includes two boards that together allow the performance of the **ADE7953** single phase energy metering IC to be evaluated. The **ADE7953** evaluation kit includes

evaluation software, written in LabVIEW®, that provides access to the registers of the **ADE7953** using a PC interface.

This document provides information about using the evaluation kit to evaluate the **ADE7953** silicon. For detailed information about the **ADE7953** IC, see the **ADE7953** data sheet.

ADE7953 INTERFACE AND EVALUATION BOARDS

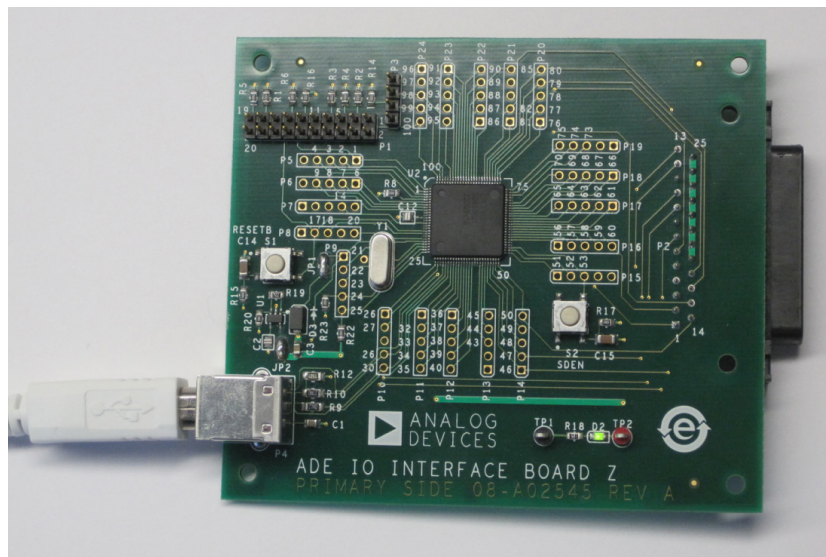

Figure 1. Interface Board

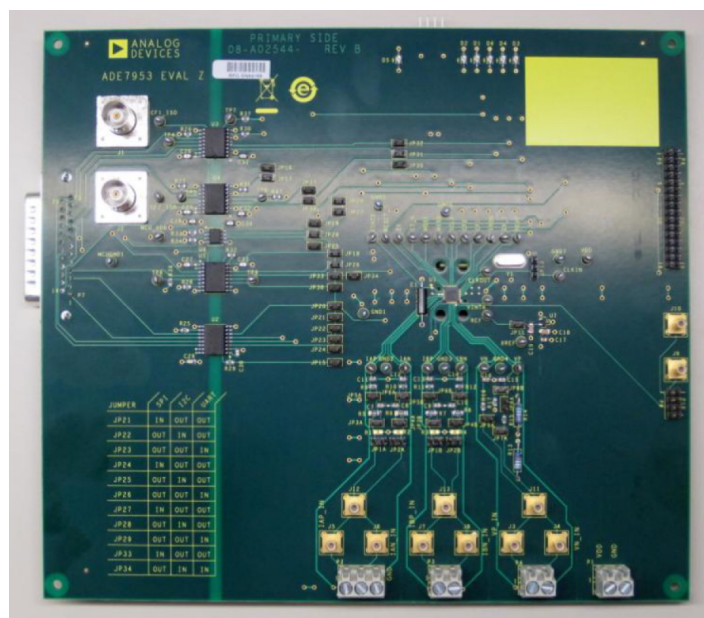

Figure 2. Evaluation Board

TABLE OF CONTENTS

General Description	1	Evaluation Software Functions	9
ADE7953 Interface and Evaluation Boards	1	Active Energy	9
Revision History	2	Reactive Energy	10
Evaluation Board Hardware.....	3	Apparent Energy.....	10
Overview.....	3	Waveform Sampling.....	11
Powering Up the Evaluation Board.....	3	ADE7953 Interrupts.....	11
Jumper Configuration.....	3	Power Quality	11
Installing the Evaluation Board Software.....	7	Read and Write Registers	12
Installing the Drivers	7	Access All Registers.....	12
Installing the Evaluation Software	8	Reset	13
Running the Evaluation Software.....	8	Troubleshooting.....	13
Troubleshooting the Launch	8	Evaluation Board Schematics.....	14
		Interface Board Schematics.....	16

REVISION HISTORY

1/13—Rev. 0 to Rev. A

Changes to Table 1	3
Changes to the Installing the Drivers Section	7
Changes to the Installing the Evaluation Software Section	8
Changes to the Running the Evaluation Software Section.....	8

3/11—Revision 0: Initial Version

EVALUATION BOARD HARDWARE

OVERVIEW

The [ADE7953](#) evaluation kit includes two boards that should be used together to evaluate the silicon. The smaller board, named ADE IO INTERFACE BOARD Z (the interface board), consists of an NXP LPC2368FBD100 microcontroller that handles all communications from the PC to the [ADE7953](#) (see Figure 1). The larger board, named EVAL-ADE7953EBZ (the evaluation board), includes the [ADE7953](#) energy metering IC, associated filtering, and isolation to allow high voltage inputs to be used (see Figure 2). The two boards should be connected together using the 25-pin connector included in the evaluation kit. The connector is labeled P2 on the interface board and P7 on the evaluation board.

Full schematics of the [ADE7953](#) evaluation board and interface board are provided in the Evaluation Board Schematics section and the Interface Board Schematics section.

POWERING UP THE EVALUATION BOARD

The [ADE7953](#) interface board receives power via the USB cable that is connected to the PC. No additional power source is required for the interface board.

The [ADE7953](#) evaluation board requires a 3.3 V power supply. This power source supplies the nonisolated side of the circuit, including the [ADE7953](#) energy metering IC and associated circuitry. The 3.3 V supply should be provided on P1. The isolated portion of the evaluation board is powered by the interface board connection.

JUMPER CONFIGURATION

Table 1 describes the jumpers included on the [ADE7953](#) evaluation board and the required settings for different configurations. Before connecting any high voltage signals, users should review the jumper configuration and verify that it is correct for their specific setup.

Table 1. Jumper Configuration

Jumper	Option	Description
JP1A	Closed	Connects Pin 1 of the Channel IA pin connector (P2) to AGND. Use this configuration in conjunction with JP3A and JP5A closed to short the IAP pin of the ADE7953 to AGND.
	Open (default)	Pin 1 of the Channel IA pin connector (P2) is left floating. Use this configuration in normal operation to drive IAP with analog signal.
JP1B	Closed	Connects Pin 1 of the Channel IB pin connector (P3) to AGND. Use this configuration in conjunction with JP3B and JP5B closed to short the IBP pin of the ADE7953 to AGND.
	Open (default)	Pin 1 of the Channel IB pin connector (P3) is left floating. Use this configuration in normal operation to drive IBP with analog signal.
JP2A	Closed	Connects Pin 2 of the Channel IA pin connector (P2) to AGND. Use this configuration in conjunction with JP4A closed and JP6A open to short the IAN pin of the ADE7953 to AGND, which should be done when using a shunt current sensor.
	Open (default)	Pin 2 of the Channel IA pin connector (P2) is left floating. Use this configuration when driving a differential input to IAN, which should be done when using a current transformer or Rogowski coil sensor.
JP2B	Closed	Connects Pin 2 of the Channel IB pin connector (P3) to AGND. Use this configuration in conjunction with JP4B closed and JP6B open to short the IBN pin of the ADE7953 to AGND, which should be done when using a shunt current sensor.
	Open (default)	Pin 2 of the Channel IB pin connector (P3) is left floating. Use this configuration when driving a differential input to IBN, which should be done when using a current transformer or Rogowski coil sensor.
JP3A	Closed	Disables the antialiasing filter (composed of R5 and C7) in the IAP signal path.
	Open (default)	Enables the antialiasing filter (composed of R5 and C7) in the IAP signal path.
JP3B	Closed	Disables the antialiasing filter (composed of R7 and C9) in the IBP signal path.
	Open (default)	Enables the antialiasing filter (composed of R7 and C9) in the IBP signal path.
JP4A	Closed	Disables the antialiasing filter (composed of R6 and C8) in the IAN signal path.
	Open (default)	Enables the antialiasing filter (composed of R6 and C8) in the IAN signal path.
JP4B	Closed	Disables the antialiasing filter (composed of R8 and C10) in the IBN signal path.
	Open (default)	Enables the antialiasing filter (composed of R8 and C10) in the IBN signal path.
JP5A	Closed (default)	Disables the antialiasing filter (composed of R9 and C11) in the IAP signal path.
	Open	Enables the antialiasing filter (composed of R9 and C11) in the IAP signal path.

Jumper	Option	Description
JP5B	Closed (default)	Disables the antialiasing filter (composed of R11 and C13) in the IBP signal path.
	Open	Enables the antialiasing filter (composed of R11 and C13) in the IBP signal path.
JP6A	Closed (default)	Disables the antialiasing filter (composed of R10 and C12) in the IAN signal path.
	Open	Enables the antialiasing filter (composed of R10 and C12) in the IAN signal path.
JP6B	Closed (default)	Disables the antialiasing filter (composed of R12 and C14) in the IBN signal path.
	Open	Enables the antialiasing filter (composed of R12 and C14) in the IBN signal path.
JP7A	Closed	Connects Pin 1 of the Channel V pin connector (P4) to AGND. Use this configuration in conjunction with JP8A closed to connect the VP pin of the ADE7953 to AGND via 1 kΩ Resistor R15.
	Open (default)	Pin 1 of the Channel V pin connector (P4) is left floating. Use this configuration in normal operation to drive VP with analog signal.
JP8A	Closed	Disables the 1000:1 attenuator network (composed of R13, R14, R15, and R17) when JP8B is open. Use this configuration when using a low voltage signal source on the voltage channel.
	Open (default)	Enables the 1000:1 attenuator network (composed of R13, R14, R15, and R17) when JP8B is closed. Use this configuration when using a high voltage signal source on the voltage channel.
JP8B	Closed (default)	Enables the 1000:1 attenuator network (composed of R13, R14, R15, and R17) when JP8A is open. Use this configuration when using a high voltage signal source on the voltage channel.
	Open	Disables the 1000:1 attenuator network (composed of R13, R14, R15, and R17) when JP8A is closed. Use this configuration when using a low voltage signal source on the voltage channel.
JP9A	Closed (default)	Connects Pin 2 of the Channel V pin connector (P4) to AGND. Use this configuration to connect the VN pin of the ADE7953 to AGND via 1 kΩ Resistor R16, which should be done when normal single-ended signals are connected to the ADE7953 voltage channel.
	Open	Pin 2 of the Channel V pin connector (P4) is left floating. Use this configuration to drive VN with a differential signal.
JP11	Closed	Connects the ADR280 voltage reference to the REF pin of the ADE7953 . Use this configuration when the ADE7953 is configured to use an external reference.
	Open (default)	Disconnects the ADR280 voltage reference from the REF pin of the ADE7953 . Use this configuration in normal operation when the ADE7953 is configured to use the internal reference.
JP13	1, 2 (default)	Connects Pin 1 of the on-board 3.579545 MHz Crystal Y1 to the CLKIN pin of the ADE7953 . Use this configuration when External Crystal Y1 is used as the clock source for the ADE7953 .
	2, 3	Disconnects Pin 1 of the on-board 3.579545 MHz Crystal Y1 from the CLKIN pin of the ADE7953 . Use this configuration when an external clock is used. This clock can be connected to Pin 6 of 16×1 Header P5.
JP15	Closed (default)	Connects the externally applied 3.3 V power to ADuM1401 Isolator U2. Use this configuration in normal operation when communicating with the ADE7953 via the interface board.
	Open	Disconnects the externally applied 3.3 V power to ADuM1401 Isolator U2. Use this configuration when isolation and/or communication is not required with the ADE7953 .
JP16	Closed (default)	Connects the externally applied 3.3 V power to ADuM1401 Isolator U3. Use this configuration in normal operation when communicating with the ADE7953 via the interface board.
	Open	Disconnects the externally applied 3.3 V power to ADuM1401 Isolator U3. Use this configuration when isolation and/or communication is not required with the ADE7953 .
JP17	Closed (default)	Connects the externally applied 3.3 V power to ADuM1401 Isolator U4. Use this configuration in normal operation when communicating with the ADE7953 via the interface board.
	Open	Disconnects the externally applied 3.3 V power to ADuM1401 Isolator U4. Use this configuration when isolation and/or communication is not required with the ADE7953 .
JP18	Closed (default)	Connects the externally applied 3.3 V power to ADuM1401 Isolator U5. Use this configuration in normal operation when communicating with the ADE7953 via the interface board.
	Open	Disconnects the externally applied 3.3 V power to ADuM1401 Isolator U5. Use this configuration when isolation and/or communication is not required with the ADE7953 .
JP19	Closed (default)	Connects the externally applied 3.3 V power to the ADuM1250 bidirectional isolator, U6. Use this configuration when communicating with the ADE7953 via the interface board using I ² C.
	Open	Disconnects the externally applied 3.3 V power to the ADuM1250 bidirectional isolator, U6. Use this configuration when isolation and/or I ² C communication is not required with the ADE7953 .

Jumper	Option	Description
JP20	Closed (default)	Connects the $\overline{\text{RESET}}$ pin of the ADE7953 to ADuM1401 Isolator U2. Use this configuration in normal operation when software management of the $\overline{\text{RESET}}$ pin is done via the interface board and the ADE7953 evaluation software.
	Open	Disconnects the $\overline{\text{RESET}}$ pin of the ADE7953 from ADuM1401 Isolator U2. Use this configuration when software management of the $\overline{\text{RESET}}$ pin is not desired.
JP21	Closed (default)	Connects the SCLK pin of the ADE7953 to ADuM1401 Isolator U3. Use this configuration when communicating with the ADE7953 via the interface board using SPI.
	Open	Disconnects the SCLK pin of the ADE7953 from ADuM1401 Isolator U3. Use this configuration when SPI communication is not required with the ADE7953 .
JP22	Closed	Connects the SCLK pin of the ADE7953 to the externally applied 3.3 V power. Use this configuration when setting up the ADE7953 to use I ² C communication.
	Open (default)	Disconnects the SCLK pin of the ADE7953 from the externally applied 3.3 V power. Use this configuration when I ² C communication is not required.
JP23	Closed	Connects the SCLK pin of the ADE7953 to AGND. Use this configuration when setting up the ADE7953 to use UART communication.
	Open (default)	Disconnects the SCLK pin of the ADE7953 from AGND. Use this configuration when UART communication is not required.
JP24	Closed (default)	Connects the MOSI/SCL/Rx pin of the ADE7953 to the MOSI pin on the interface board via ADuM1401 Isolator U4. Use this configuration when the ADE7953 is set up for SPI communication.
	Open	Disconnects the MOSI/SCL/Rx pin of the ADE7953 from the MOSI pin on the interface board via ADuM1401 Isolator U4. Use this configuration when the ADE7953 is not set up for SPI communication.
JP25	Closed	Connects the MOSI/SCL/Rx pin of the ADE7953 to the SCL pin on the interface board via the ADuM1250 bidirectional isolator, U6. Use this configuration when the ADE7953 is set up for I ² C communication.
	Open (default)	Disconnects the MOSI/SCL/Rx pin of the ADE7953 from the SCL pin on the interface board via the ADuM1250 bidirectional isolator, U6. Use this configuration when the ADE7953 is not set up for I ² C communication.
JP26	Closed	Connects the MOSI/SCL/Rx pin of the ADE7953 to the TX pin on the interface board via ADuM1401 Isolator U5. Use this configuration when the ADE7953 is set up for UART communication.
	Open (default)	Disconnects the MOSI/SCL/Rx pin of the ADE7953 from the TX pin on the interface board via ADuM1401 Isolator U5. Use this configuration when the ADE7953 is not set up for UART communication.
JP27	Closed (default)	Connects the MISO/SDA/Tx pin of the ADE7953 to the MISO pin on the interface board via ADuM1401 Isolator U2. Use this configuration when the ADE7953 is set up for SPI communication.
	Open	Disconnects the MISO/SDA/Tx pin of the ADE7953 from the MISO pin on the interface board via ADuM1401 Isolator U2. Use this configuration when the ADE7953 is not set up for SPI communication.
JP28	Closed	Connects the MISO/SDA/Tx pin of the ADE7953 to the SDA pin on the interface board via the ADuM1250 bidirectional isolator, U6. Use this configuration when the ADE7953 is set up for I ² C communication.
	Open (default)	Disconnects the MISO/SDA/Tx pin of the ADE7953 from the SDA pin on the interface board via the ADuM1250 bidirectional isolator, U6. Use this configuration when the ADE7953 is not set up for I ² C communication.
JP29	Closed	Connects the MISO/SDA/Tx pin of the ADE7953 to the RX pin on the interface board via ADuM1401 Isolator U2. Use this configuration when the ADE7953 is set up for UART communication.
	Open (default)	Disconnects the MISO/SDA/Tx pin of the ADE7953 from the RX pin on the interface board via ADuM1401 Isolator U2. Use this configuration when the ADE7953 is not set up for UART communication.
JP30	Closed (default)	Connects the ZX pin of the ADE7953 to ADuM1401 Isolator U2. Use this configuration in normal operation when software management of the ZX pin is done via the interface board and the ADE7953 evaluation software.
	Open	Disconnects the ZX pin of the ADE7953 from ADuM1401 Isolator U2. Use this configuration when software management of the ZX pin is not desired.
JP31	Closed (default)	Connects the IRQ pin of the ADE7953 to ADuM1401 Isolator U3. Use this configuration in normal operation when software management of the IRQ pin is done via the interface board and the ADE7953 evaluation software.
	Open	Disconnects the $\overline{\text{IRQ}}$ pin of the ADE7953 from ADuM1401 Isolator U3. Use this configuration when software management of the IRQ pin is not desired.
JP32	Closed (default)	Connects the ZX_I pin of the ADE7953 to ADuM1401 Isolator U3. Use this configuration in normal operation when software management of the ZX_I pin is done via the interface board and the ADE7953 evaluation software.
	Open	Disconnects the ZX_I pin of the ADE7953 from ADuM1401 Isolator U3. Use this configuration when software management of the ZX_I pin is not desired.

Jumper	Option	Description
JP33	Closed (default)	Connects the CS pin of the ADE7953 to ADuM1401 Isolator U5. Use this configuration when communicating with the ADE7953 via the interface board using SPI.
	Open	Disconnects the CS pin of the ADE7953 from ADuM1401 Isolator U5. Use this configuration when isolation and/or SPI communication is not required with the ADE7953 .
JP34	Closed	Connects the CS pin of the ADE7953 to the externally applied 3.3 V power. Use this configuration when using either I ² C or UART communication.
	Open (default)	Disconnects the CS pin of the ADE7953 from the externally applied 3.3 V power. Use this configuration when the ADE7953 is configured for SPI communication.
JP36	Closed (default)	Connects the $\overline{\text{REVP}}$ pin of the ADE7953 to ADuM1401 Isolator U4. Use this configuration in normal operation when software management of the $\overline{\text{REVP}}$ pin is done via the interface board and the ADE7953 evaluation software.
	Open	Disconnects the $\overline{\text{REVP}}$ pin of the ADE7953 from ADuM1401 Isolator U4. Use this configuration when software management of the $\overline{\text{REVP}}$ pin is not desired.
JP37	Closed (default)	Connects the CF1 pin of the ADE7953 to CF1_ISO BNC Connector J1 via ADuM1401 Isolator U4. Use this configuration when the isolated interface to CF1 is required.
	Open	Disconnects the CF1 pin of the ADE7953 from CF1_ISO BNC Connector J1 via ADuM1401 Isolator U4. Use this configuration when the isolated interface to CF1 is not required.
JP38	Closed (default)	Connects the CF2 pin of the ADE7953 to CF2_ISO BNC Connector J2 via ADuM1401 Isolator U5. Use this configuration when the isolated interface to CF2 is required.
	Open	Disconnects the CF2 pin of the ADE7953 from CF2_ISO BNC Connector J2 via ADuM1401 Isolator U5. Use this configuration when the isolated interface to CF2 is not required.

INSTALLING THE EVALUATION BOARD SOFTWARE

INSTALLING THE DRIVERS

When using the [ADE7953](#) evaluation tools for the first time, a driver must be installed to allow successful communication. To obtain the driver, download the evaluation board software ([ADE7953_evalboard_software.zip](#)) from the [ADE7953 evaluation board Web page](#). The driver can be found in the [VirCOM_Driver_XP](#) folder.

There are two folders within the [VirCOM_Driver_XP](#) folder.

- The **Windows XP and VISTA** folder contains the driver suitable for 32-bit operating systems, such as Windows XP and the 32-bit version of Windows Vista®.
- The **Windows 7 (64 bit)** folder contains the driver suitable for 64-bit operating systems, such as Windows 7.

Select the appropriate driver based on the operating system used on the PC. To install the driver, follow this procedure.

1. Connect the USB cable from the PC to the interface board. The **Found New Hardware Wizard** window appears, indicating that the PC has detected the new hardware.



Figure 3. Found New Hardware Wizard Window

2. If you are installing the driver on a system running Windows 7, the **Found New Hardware Wizard** may not appear. To manually select the driver, follow these steps.
 - a. Choose **Control Panel > Hardware and Sound > Device Manager**; locate the new hardware under the **Ports** heading.
 - b. Right-click the port and select **Update Driver Software**.
 - c. Select **Browse my Computer for Driver Software**. The window shown in Figure 4 appears.
 - d. Go to Step 4.

3. In the **Found New Hardware Wizard** window (see Figure 3), select the **Install from a list or specific location (Advanced)** option and click **Next**.

The following window opens (see Figure 4).

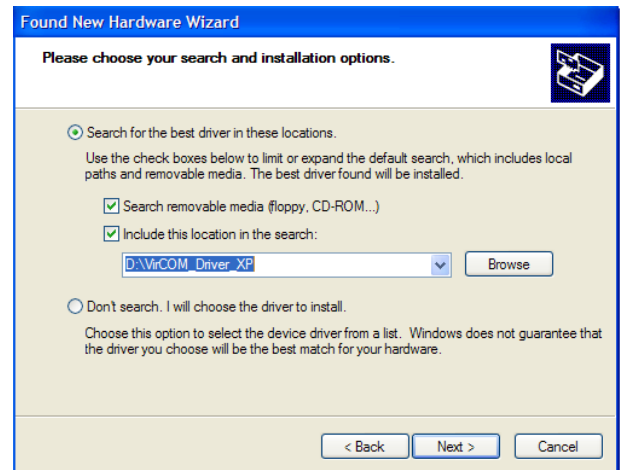

Figure 4. Search for Driver Window

4. Select **Search removable media (floppy, CD-ROM)** and **Include this location in the search** (see Figure 4). Use the **Browse** button to locate the **Windows XP and VISTA** or **Windows 7 (64 bit)** folder in the [VirCOM_Driver_XP](#) folder downloaded from the [ADE7953 evaluation board Web page](#).
5. Click **Next**.

The **Hardware Installation** window appears, stating that the hardware did not pass the Windows Logo test.

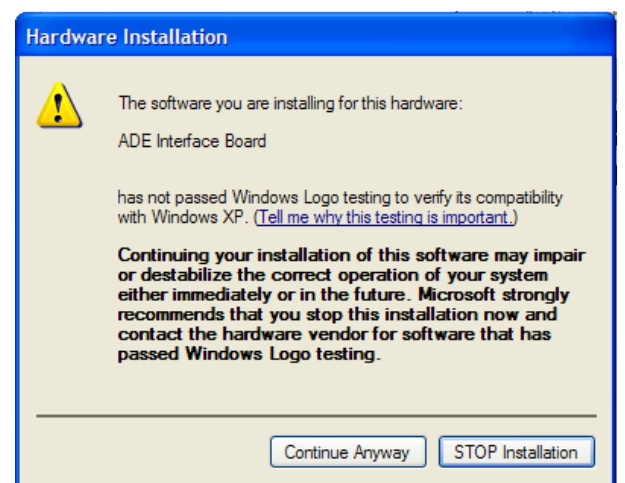

Figure 5. Hardware Installation Window

6. Click **Continue Anyway**. When the installation is complete, the window shown in Figure 6 appears.



Figure 6. Installation Complete Window

7. Click **Finish** to close the window.

INSTALLING THE EVALUATION SOFTWARE

The evaluation software is available in the [ADE7953_evalboard_software.zip](#) file, which can be downloaded from the [ADE7953 evaluation board Web page](#). The software can be run even if a licensed copy of LabVIEW is not available.

If the [ADE7953](#) evaluation software will be used on the PC for the first time, an installer must be run. This installer is available in the [ADE7953_RevG_Installer](#) folder.

To run the LabVIEW 2010 installer, follow these steps:

1. Locate the [ADE7953_RevG_Installer](#) folder and double-click the **setup.exe** file.
2. Follow the prompts to install the LabVIEW 2010 run-time engine.

When the installation is complete, the [ADE7953](#) evaluation software opens automatically and a shortcut is added to the **Start** menu. This shortcut can be found by selecting **Programs > ADE7953_Eval_RevG**.

RUNNING THE EVALUATION SOFTWARE

After the installation process is complete, the software can be run by opening the [ADE7953_Eval_RevG](#) program from the **Start** menu.

When the evaluation software is running, it should automatically detect the COM port that the [ADE7953](#) interface board is connected to. If the port detection is successful, the COM port number appears in the **Port Control** field, as shown in Figure 7 (COM3 in this example).

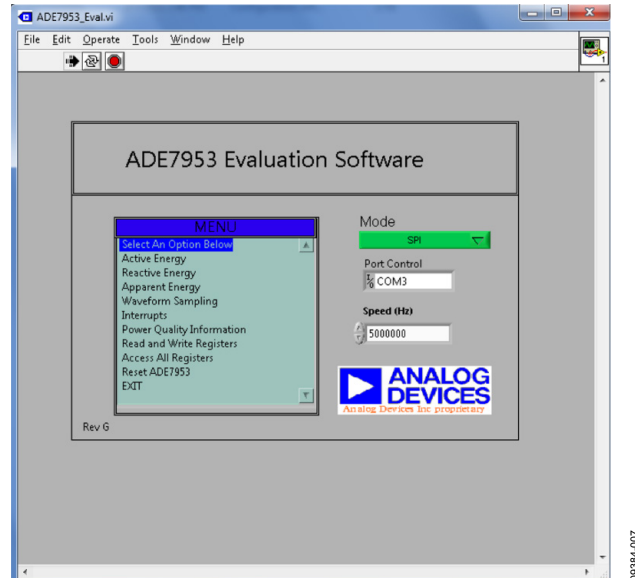

Figure 7. Main Window

Note that supply power to the evaluation board is not required for COM port detection. The interface board is powered from the USB connection from the PC.

TROUBLESHOOTING THE LAUNCH

If the software does not detect the communications port, the message shown in Figure 8 is displayed.

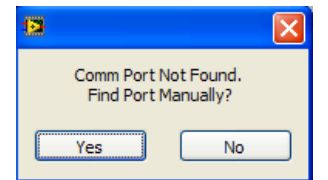

Figure 8. Comm Port Not Found Message

If this message appears, the following steps should be taken:

1. Click **Yes** to return to the main window (see Figure 7).
2. Verify that the interface board is connected to the PC using the USB cable.
3. Ensure that the required drivers are installed as described in the [Installing the Drivers](#) section.
4. Using the **Device Manager** tool, ensure that the port is operating correctly.
5. Manually select the correct COM port by clicking the **Port Control** tab in the main window.

EVALUATION SOFTWARE FUNCTIONS

The ADE7953 evaluation software allows access to all registers and features of the ADE7953 using SPI, I²C, or UART communication. The communication mode and speed should be set in the main window (see Figure 7). The menu options available are

- Active Energy
- Reactive Energy
- Apparent Energy
- Waveform Sampling
- Interrupts
- Power Quality Information
- Read and Write Registers
- Access All Registers
- Reset ADE7953
- EXIT (stops LabVIEW)

These options provide access to all internal registers and allow the evaluation of ADE7953 performance. To access these functions, click the desired option in the MENU box (see Figure 7).

Clicking an option in the MENU box displays a window where the specific function can be accessed. Each window includes an EXIT button that should be used to return to the main window.

Note that only one option from the MENU box can be open at a time; click EXIT to return to the main window before choosing another option from the MENU box.

ACTIVE ENERGY

The Active Energy window is shown in Figure 10. This window allows access to all registers associated with the active energy measurement.

The tabs at the top of the window allow registers associated with Current Channel A or Current Channel B to be accessed. A register can be read by clicking **READ All Registers**. Register modifications can be made directly on the signal path diagram; these modifications are written to the part by clicking **WRITE All Registers**.

From the **Active Energy** window, the **CF Outputs** window can be accessed by clicking **CF Output**. Clicking **CF Output** opens the window shown in Figure 9.

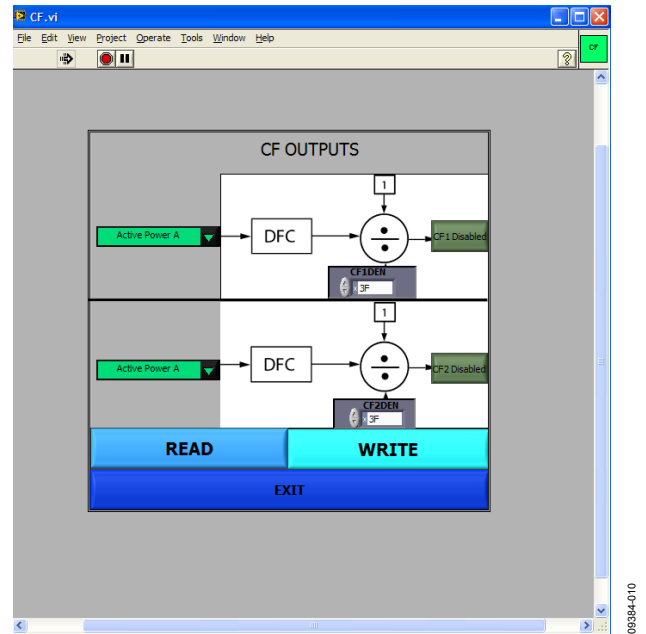

Figure 9. CF Outputs Window

From this window, the functionality of the CF1 and CF2 output pins can be selected.

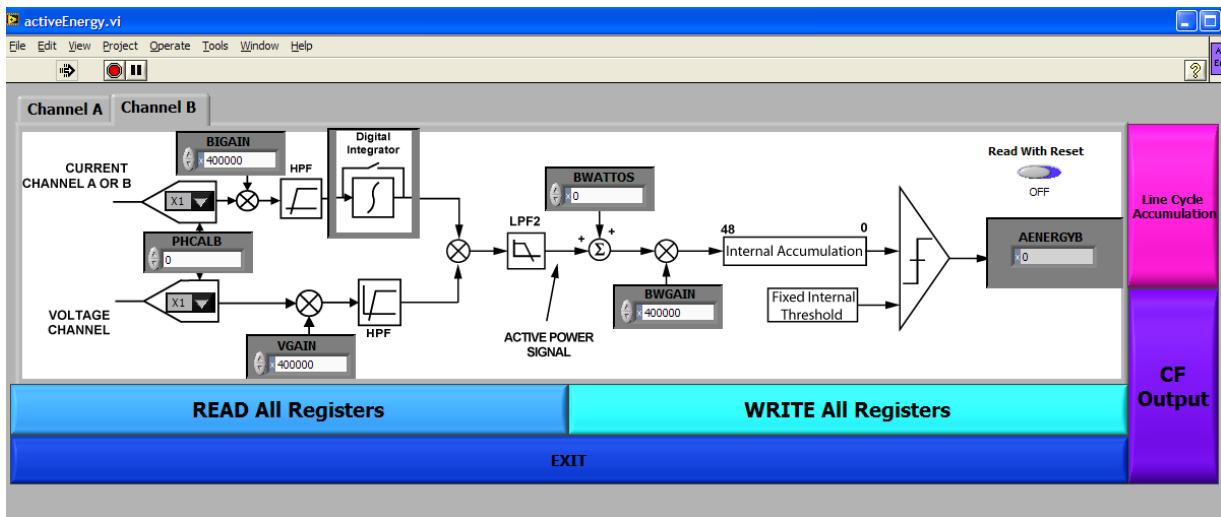

Figure 10. Active Energy Window

The **Line Cycle Accumulation** window is also accessible from the **Active Energy** window (see Figure 11).



Figure 11. Line Cycle Accumulation Window

The line cycle mode allows energy to be accumulated over an integral number of half line cycles. To activate line cycle accumulation, an ac signal must be present on the voltage channel. Click **EXIT** in the **CF Outputs** or **Line Cycle Accumulation** window to return to the **Active Energy** window.

REACTIVE ENERGY

The **Reactive Energy** window is available from the **MENU** box. This window is similar to the **Active Energy** window shown in Figure 10, but it allows access to registers that are associated with the reactive energy measurements. Tabs are available to select Current Channel A or Current Channel B registers. The **CF Outputs** and **Line Cycle Accumulation** windows are also accessible from the **Reactive Energy** window (see Figure 9 and Figure 11, respectively).

APPARENT ENERGY

The **Apparent Energy** window is available from the **MENU** box. The **Apparent Energy** window allows access to the registers associated with the apparent energy measurement (see Figure 13). Tabs are available to select Current Channel A or Current Channel B registers.

The **CF Outputs** and **Line Cycle Accumulation** windows shown in Figure 9 and Figure 11 are also accessible from the **Apparent Energy** window.

Apparent energy measurement is derived from the product of the current rms and voltage rms measurements. The **RMS** window can be accessed from the **Apparent Energy** window by clicking **Voltage RMS** or **Current RMS** (see Figure 12).

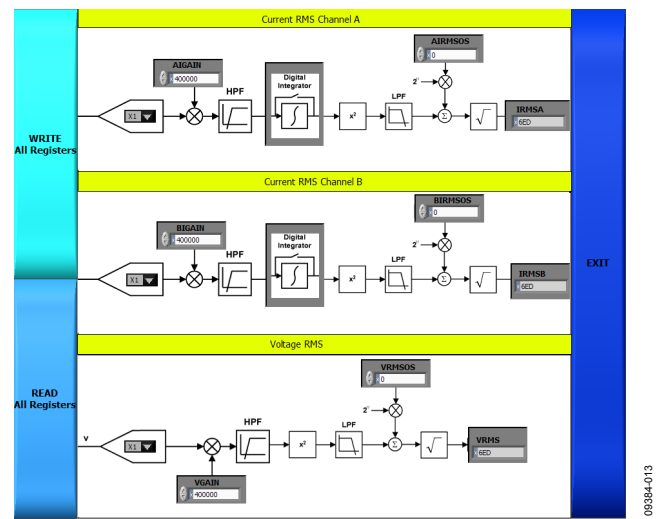

Figure 12. RMS Window

From the **RMS** window, the calibration and configuration registers associated with the VRMS and IRMS measurements can be accessed. In addition, the rms readings can be obtained. Click **EXIT** in this window to return to the **Apparent Energy** window.

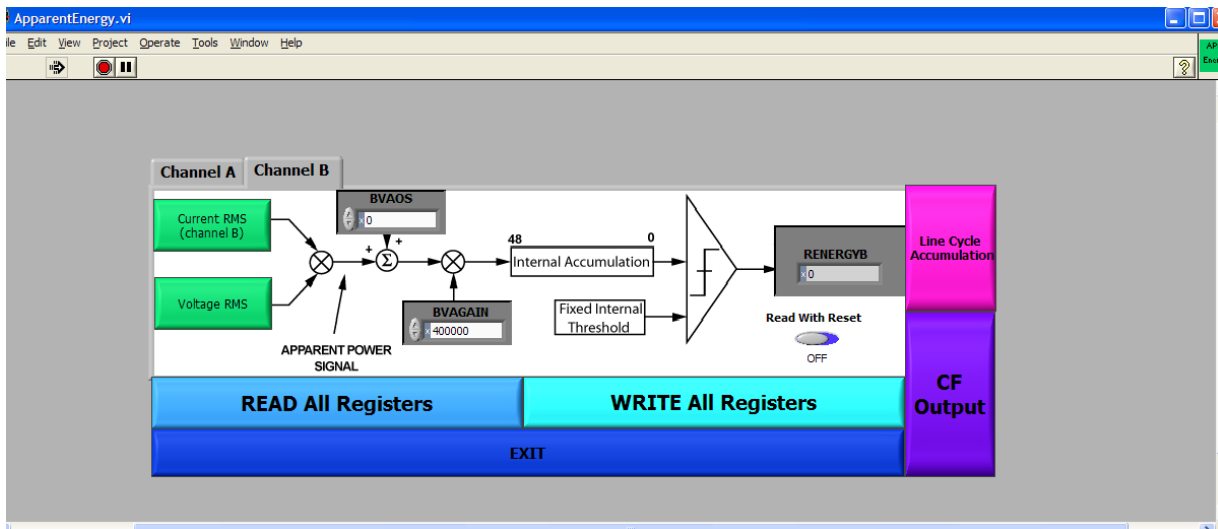

Figure 13. Apparent Energy Window

WAVEFORM SAMPLING

The **Waveform Sampling** window is available from the **MENU** box. The **Waveform Sampling** window is shown in Figure 14. To use the **Waveform Sampling** window, SPI must be selected as the communication interface (see Figure 7).

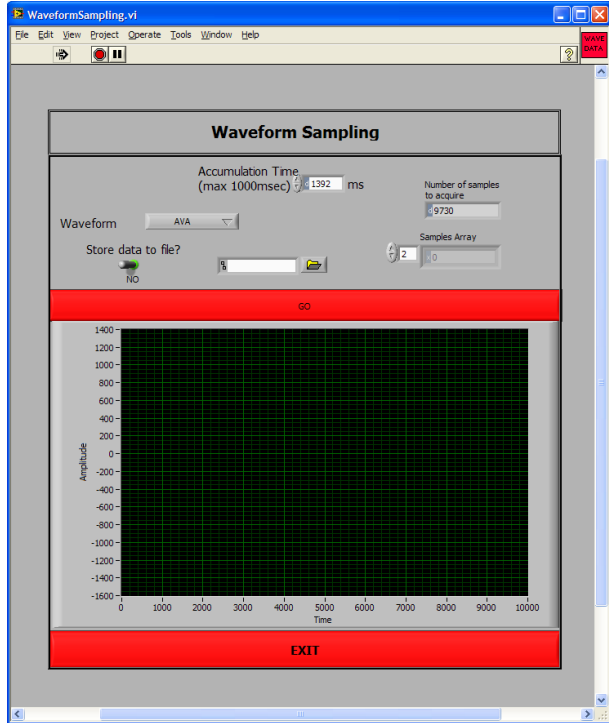

Figure 14. Waveform Sampling Window

This window allows raw waveform data to be captured and displayed on a graph. To save the data to a file, click the **Store data to file?** toggle switch and enter a destination file name in the adjacent box.

ADE7953 INTERRUPTS

The **ADE7953 Interrupts** window is available from the **MENU** box. The **ADE7953 Interrupts** window is shown in Figure 15.

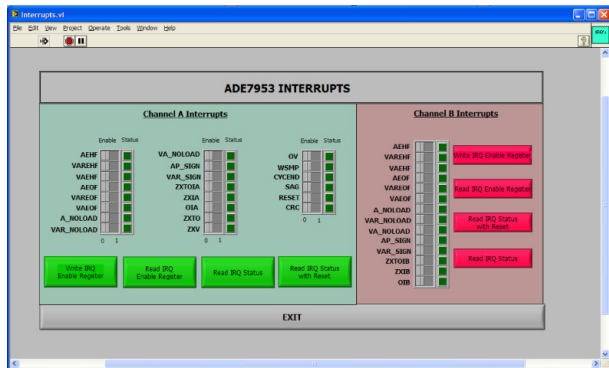

Figure 15. ADE7953 Interrupts Window

This window allows access to the status and enable registers associated with the Current Channel A, Current Channel B, and voltage channel interrupts.

The switch buttons in the **ADE7953 Interrupts** window allow the individual interrupt enable bits to be selected. After the appropriate interrupt enable bits are selected, they can be written to the part by clicking **Write IRQ Enable Register**.

The lights represent the corresponding interrupt status registers. These registers can be read and reset by clicking **Read IRQ Status** or **Read IRQ Status with Reset**.

POWER QUALITY

The **Power Quality** window is available from the **MENU** box. The **Power Quality** window is shown in Figure 16.

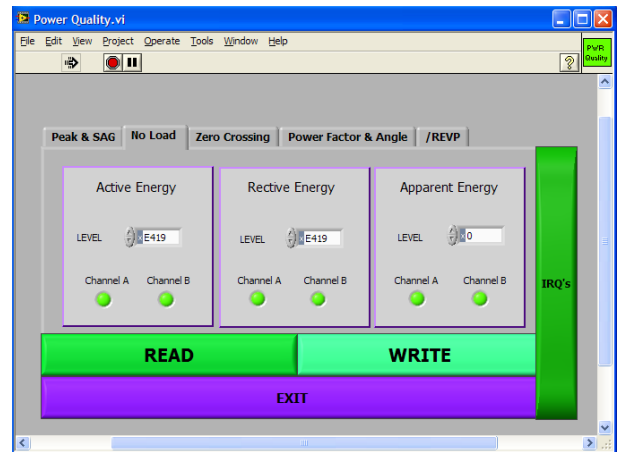

Figure 16. Power Quality Window

The following features can be configured using the **Power Quality** window:

- Peak detection
- Sag detection
- No-load detection
- Zero-crossing detection
- Power factor measurement
- Angle measurement
- Reverse power

The tabs in the **Power Quality** window are used to select the appropriate feature. Each feature can be configured and then written to the part by clicking **WRITE**. The **ADE7953 Interrupts** window shown in Figure 15 can be accessed from the **Power Quality** window by clicking **IRQ's**.

READ AND WRITE REGISTERS

The **Read and Write Registers** window is available from the **MENU** box. The **Read and Write Registers** window is shown in Figure 17.

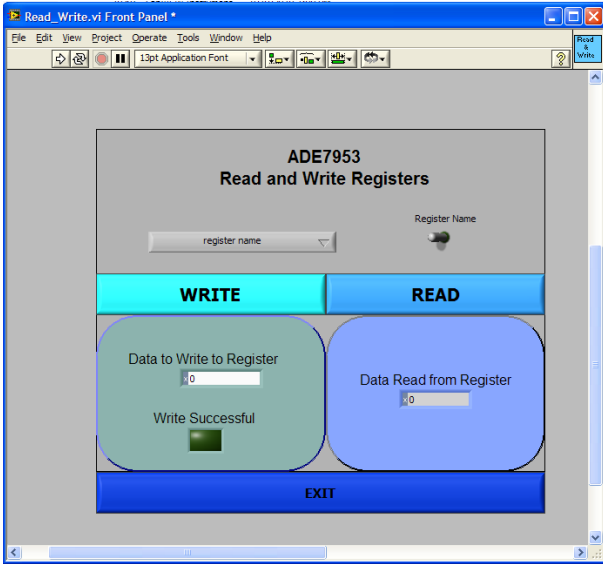

Figure 17. Read and Write Registers Window

An individual register can be accessed from this window by selecting the register name from the pull-down menu. Alternatively, registers can be accessed by address by clicking the **Register Name** toggle switch and then typing the address and size of a register into the register address and register size boxes.

ACCESS ALL REGISTERS

The **Access All Registers** window is available from the **MENU** box. The **Access All Registers** window allows all the registers in the **ADE7953** to be accessed at once (see Figure 18).

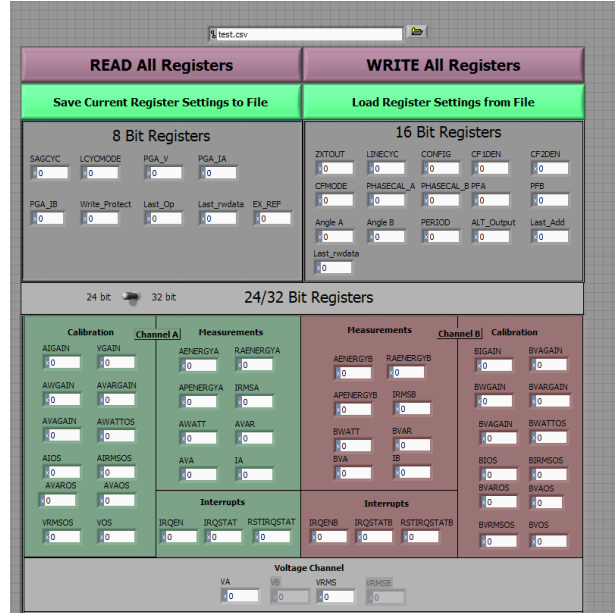

Figure 18. Access All Registers Window

The entire **ADE7953** register bank can be read or modified by clicking **READ All Registers** or **WRITE All Registers**. The current configuration can be saved to a comma-separated variable (.csv) file by specifying a destination file at the top of the window and then clicking **Save Current Register Settings to File**.

To load a configuration from a file, specify a configuration file at the top of the window and then click **Load Register Settings from File**. The contents of the specified .csv file are written to the **ADE7953**.

RESET

The **Reset** window is available from the **MENU** box. The **Reset** window is shown in Figure 19.

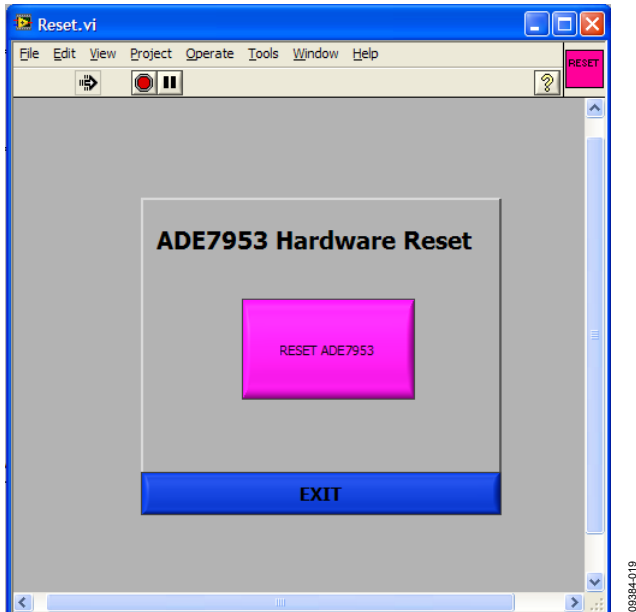

Figure 19. Reset Window

When the **RESET ADE7953** button is clicked, a hardware reset is performed on the **ADE7953**. All register data is lost and the part must be reconfigured.

TROUBLESHOOTING

Communication Failure

If communication to the **ADE7953** is not successful, the warning message shown in Figure 20 is displayed.

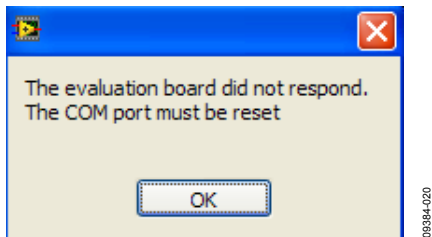

Figure 20. Communication Unsuccessful Message

This message indicates that the **ADE7953** did not respond and the communication timed out. The communication port on the PC must be reset to restore communication to the **ADE7953**. When the **OK** button is clicked, the **Clear Port** window appears (see Figure 21).

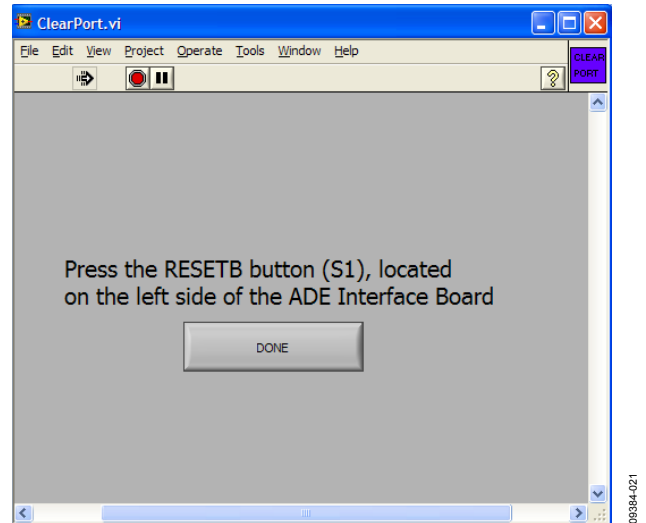

Figure 21. Clear Port Window

When the **Clear Port** window appears, press the S1 push-button located above the PC connection on the **ADE7953** interface port to reset the PC COM port (see Figure 1). After completing this action, click **DONE** in the **Clear Port** window.

Before continuing with the evaluation of the **ADE7953**, the reason for the communication failure should be investigated. After the COM port is cleared, the window shown in Figure 22 is displayed to provide some possible reasons for the failed communication.

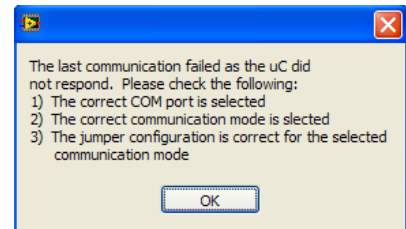

Figure 22. Error Debug Window

After clicking **OK**, click **EXIT** in the main window (see Figure 7). To troubleshoot the problem, verify the following items:

- The selected COM port is correct in the main window (see Figure 7).
- The currently configured communication mode is correct in the main window (see Figure 7).
- The correct jumpers are installed for the selected communication interface (see Table 1).

Incorrect Register Readings

If the data read back from the **ADE7953** registers is always FFFF, a possible cause is that the **ADE7953** is not correctly powered. Ensure that a 3.3 V supply has been supplied to the **ADE7953**, as described in the Powering Up the Evaluation Board section.

EVALUATION BOARD SCHEMATICS

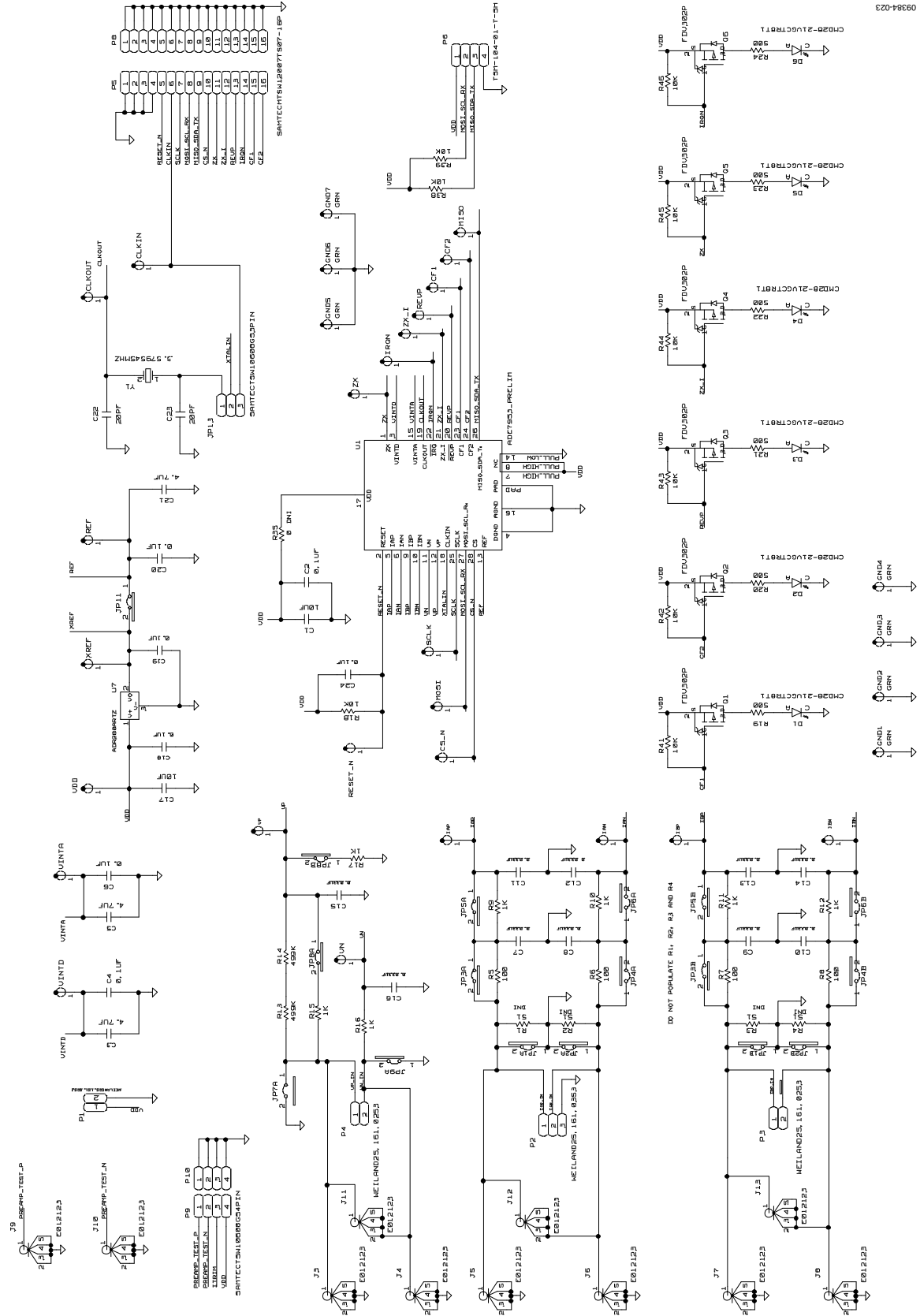

09384-023

Figure 23. Evaluation Board Schematic (Page 1)

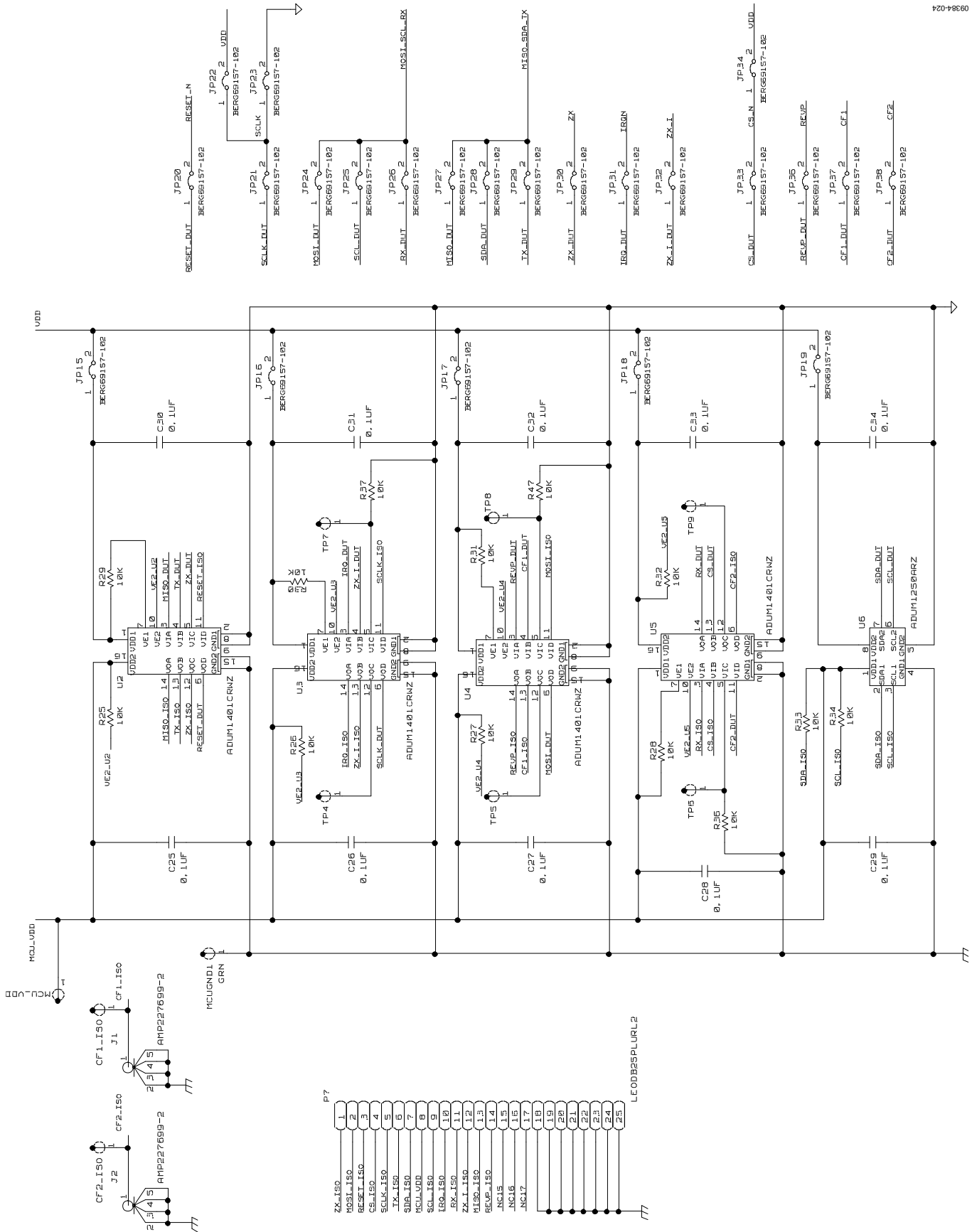
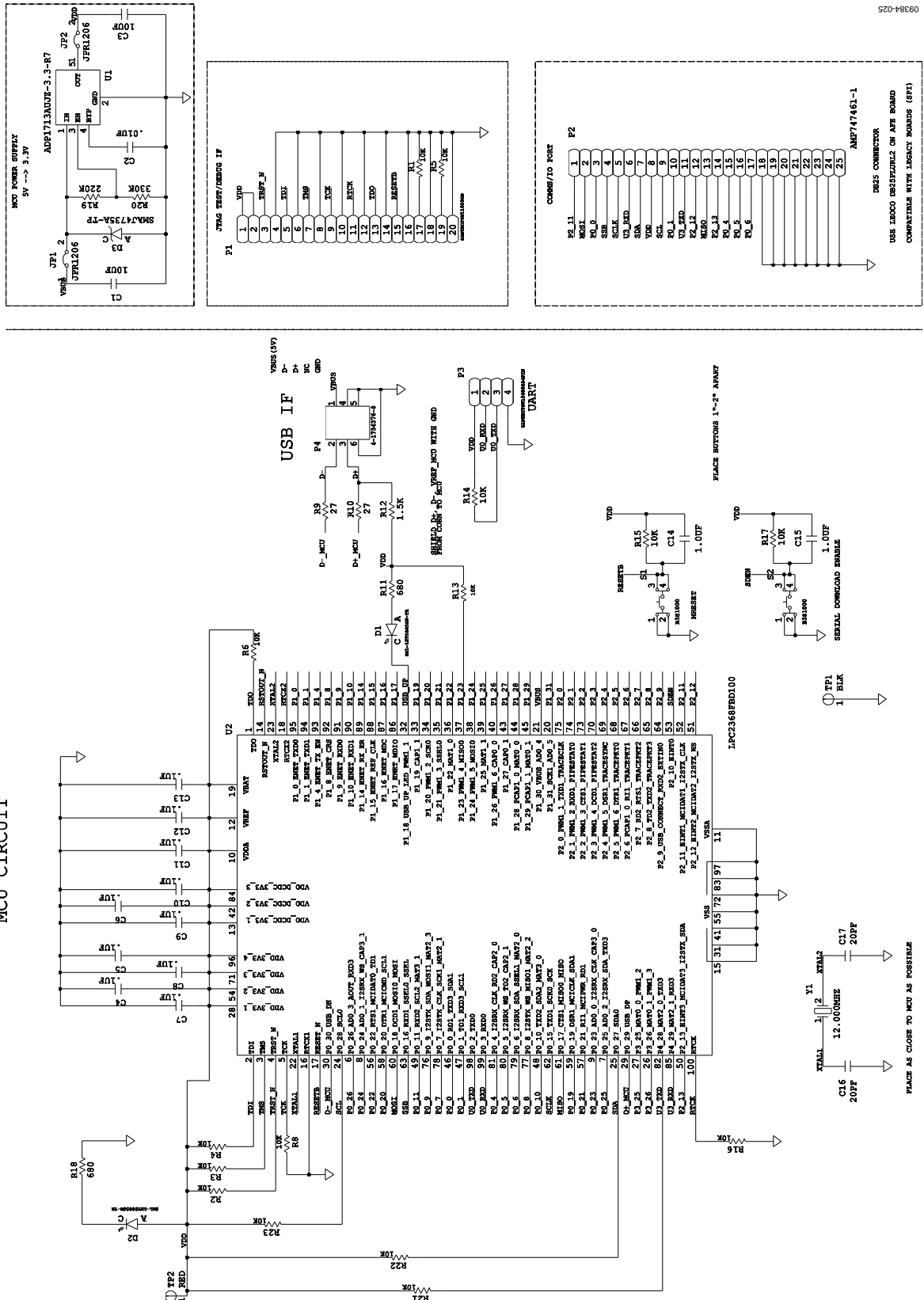

Figure 24. Evaluation Board Schematic (Page 2)

INTERFACE BOARD SCHEMATICS



S20-198460

Figure 25. Interface Board Schematic (Page 1)

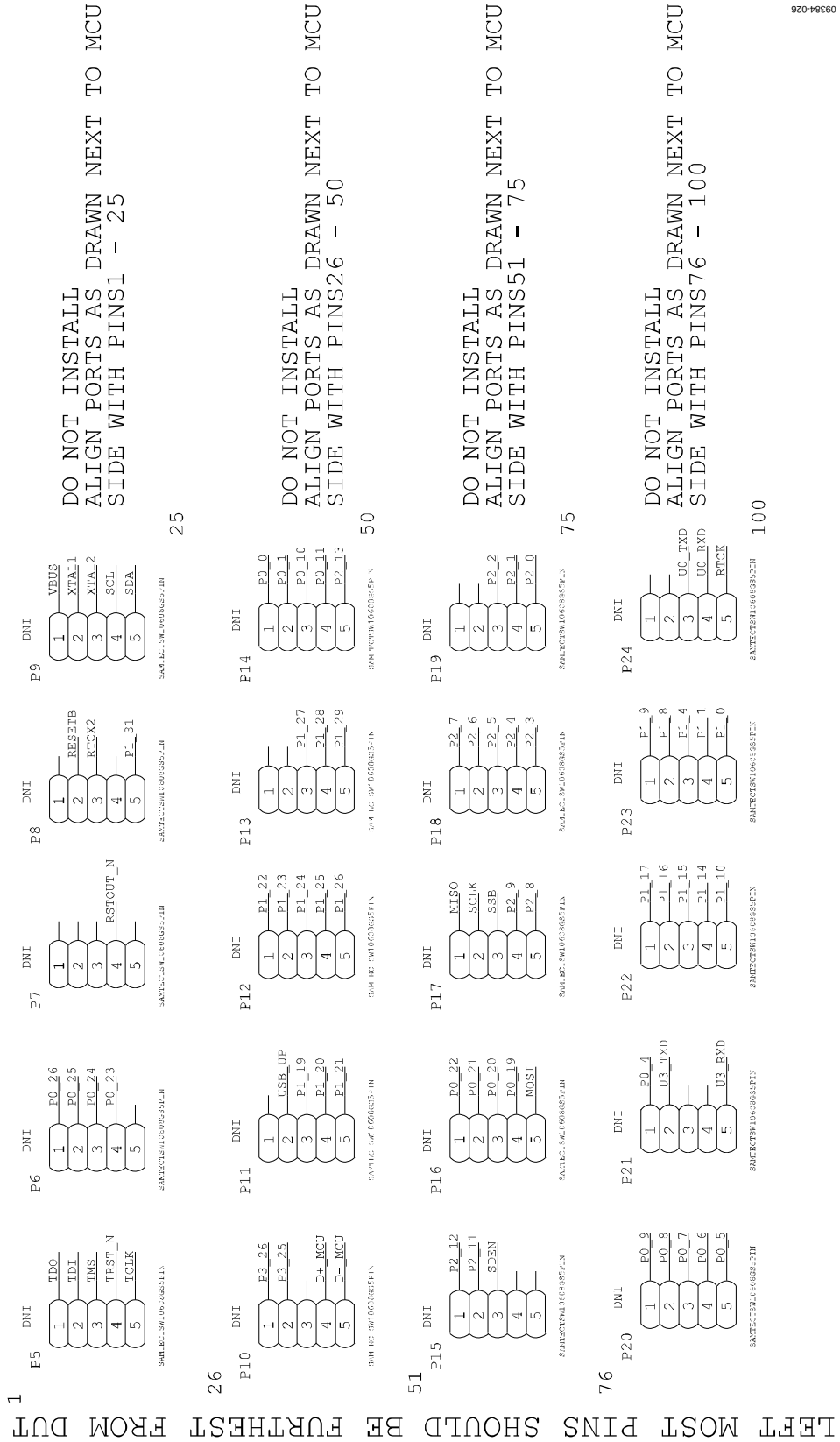

NOTES

NOTES

NOTES

**ESD Caution**

ESD (electrostatic discharge) sensitive device. Charged devices and circuit boards can discharge without detection. Although this product features patented or proprietary protection circuitry, damage may occur on devices subjected to high energy ESD. Therefore, proper ESD precautions should be taken to avoid performance degradation or loss of functionality.

Legal Terms and Conditions

By using the evaluation board discussed herein (together with any tools, components documentation or support materials, the "Evaluation Board"), you are agreeing to be bound by the terms and conditions set forth below ("Agreement") unless you have purchased the Evaluation Board, in which case the Analog Devices Standard Terms and Conditions of Sale shall govern. Do not use the Evaluation Board until you have read and agreed to the Agreement. Your use of the Evaluation Board shall signify your acceptance of the Agreement. This Agreement is made by and between you ("Customer") and Analog Devices, Inc. ("ADI"), with its principal place of business at One Technology Way, Norwood, MA 02062, USA. Subject to the terms and conditions of the Agreement, ADI hereby grants to Customer a free, limited, personal, temporary, non-exclusive, non-sublicensable, non-transferable license to use the Evaluation Board FOR EVALUATION PURPOSES ONLY. Customer understands and agrees that the Evaluation Board is provided for the sole and exclusive purpose referenced above, and agrees not to use the Evaluation Board for any other purpose. Furthermore, the license granted is expressly made subject to the following additional limitations: Customer shall not (i) rent, lease, display, sell, transfer, assign, sublicense, or distribute the Evaluation Board; and (ii) permit any Third Party to access the Evaluation Board. As used herein, the term "Third Party" includes any entity other than ADI, Customer, their employees, affiliates and in-house consultants. The Evaluation Board is NOT sold to Customer; all rights not expressly granted herein, including ownership of the Evaluation Board, are reserved by ADI. CONFIDENTIALITY. This Agreement and the Evaluation Board shall all be considered the confidential and proprietary information of ADI. Customer may not disclose or transfer any portion of the Evaluation Board to any other party for any reason. Upon discontinuation of use of the Evaluation Board or termination of this Agreement, Customer agrees to promptly return the Evaluation Board to ADI. ADDITIONAL RESTRICTIONS. Customer may not disassemble, decompile or reverse engineer chips on the Evaluation Board. Customer shall inform ADI of any occurred damages or any modifications or alterations it makes to the Evaluation Board, including but not limited to soldering or any other activity that affects the material content of the Evaluation Board. Modifications to the Evaluation Board must comply with applicable law, including but not limited to the RoHS Directive. TERMINATION. ADI may terminate this Agreement at any time upon giving written notice to Customer. Customer agrees to return to ADI the Evaluation Board at that time. LIMITATION OF LIABILITY. THE EVALUATION BOARD PROVIDED HEREUNDER IS PROVIDED "AS IS" AND ADI MAKES NO WARRANTIES OR REPRESENTATIONS OF ANY KIND WITH RESPECT TO IT. ADI SPECIFICALLY DISCLAIMS ANY REPRESENTATIONS, ENDORSEMENTS, GUARANTEES, OR WARRANTIES, EXPRESS OR IMPLIED, RELATED TO THE EVALUATION BOARD INCLUDING, BUT NOT LIMITED TO, THE IMPLIED WARRANTY OF MERCHANTABILITY, TITLE, FITNESS FOR A PARTICULAR PURPOSE OR NON-INFRINGEMENT OF INTELLECTUAL PROPERTY RIGHTS. IN NO EVENT WILL ADI AND ITS LICENSORS BE LIABLE FOR ANY INCIDENTAL, SPECIAL, INDIRECT, OR CONSEQUENTIAL DAMAGES RESULTING FROM CUSTOMER'S POSSESSION OR USE OF THE EVALUATION BOARD, INCLUDING BUT NOT LIMITED TO LOST PROFITS, DELAY COSTS, LABOR COSTS OR LOSS OF GOODWILL. ADI'S TOTAL LIABILITY FROM ANY AND ALL CAUSES SHALL BE LIMITED TO THE AMOUNT OF ONE HUNDRED US DOLLARS (\$100.00). EXPORT. Customer agrees that it will not directly or indirectly export the Evaluation Board to another country, and that it will comply with all applicable United States federal laws and regulations relating to exports. GOVERNING LAW. This Agreement shall be governed by and construed in accordance with the substantive laws of the Commonwealth of Massachusetts (excluding conflict of law rules). Any legal action regarding this Agreement will be heard in the state or federal courts having jurisdiction in Suffolk County, Massachusetts, and Customer hereby submits to the personal jurisdiction and venue of such courts. The United Nations Convention on Contracts for the International Sale of Goods shall not apply to this Agreement and is expressly disclaimed.